

FrelTec

Mathildenstr. 10A
82319 Starnberg
Germany

High-efficiency Rectifier
DO15

DO-15

SPECIFICATION

683	HER20_Gxxx	DO15	B0X
Type	Type	Package	Packing
683: High-efficiency Rectifier	HER20_G	DO15	B0X: tape in box (paper tape) for 1,5k pc

All products according to RoHS (2015/863/EU)

FrelTec

PACKAGE OUTLINE

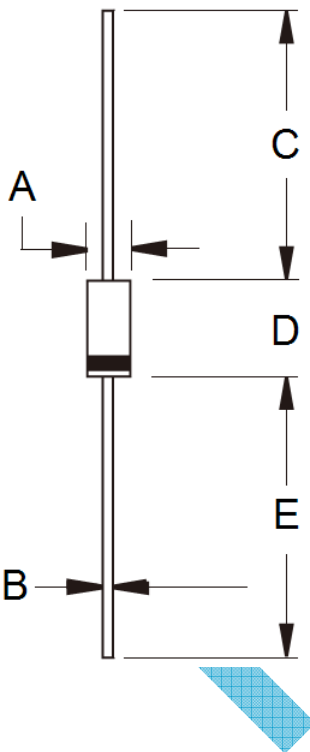
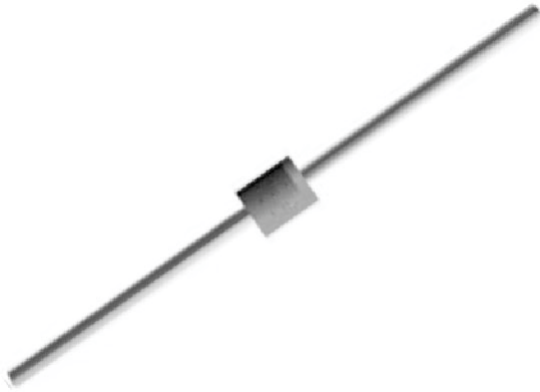

DIM.	Unit (mm)	
	Min	Max
A	2,6	3,6
B	0,7	0,9
C	25,4	-
D	5,8	7,6
E	25,4	-

DO-15

High-efficiency Rectifier

Maximum Ratings & Characteristics

Ratings at 25°C ambient temperature unless otherwise specified

Parameter	Symbols	HER	HER	HER	HER	HER	HER	HER	HER	Unit
		201 G	202 G	203 G	204 G	205 G	206 G	207 G	208 G	
Maximum repetitive peak reverse voltage	VRRM	50	100	200	300	400	600	800	1000	V
Maximum RMS voltage	VRMS	35	70	140	210	280	420	560	700	V
Maximum DC blocking voltage	VDC	50	100	200	300	400	600	800	1000	V
Maximum average forward rectified current	IF(AV)	2,0								A
Peak forward surge current 8,3 ms single half sine-wave	IFSM	60								A
Typical thermal resistance	RθJA	45								°C/W
Operating junction and storage temperature range	Tj, TSTG	-55 --- +150								°C

Electrical Characteristics Ratings at 25°C ambient temperature unless otherwise specified

Parameter	Symbols	HER	HER	HER	HER	HER	HER	HER	HER	Unit
		201 G	202 G	203 G	204 G	205 G	206 G	207 G	208 G	
IF = 2,0A Maximum forward voltage	VF	1,0			1,3		1,7			V
TA= 25°C Maximum reverse current TA=100°C	IR	5,0 200								µA
IF=0,5A IR=1,0A IRR=0,25A MAX. Reverse Recovery Time	trr	50					75			nS
VR = 4,0V, f = 1MHz Type junction capacitance	Cj	45					20			pF

DO-15

Characteristics(Typical)

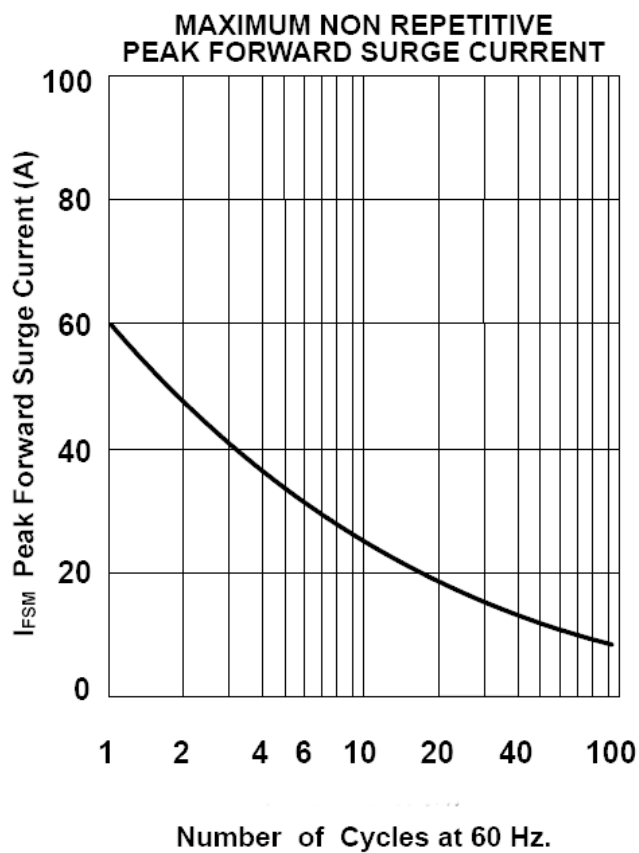
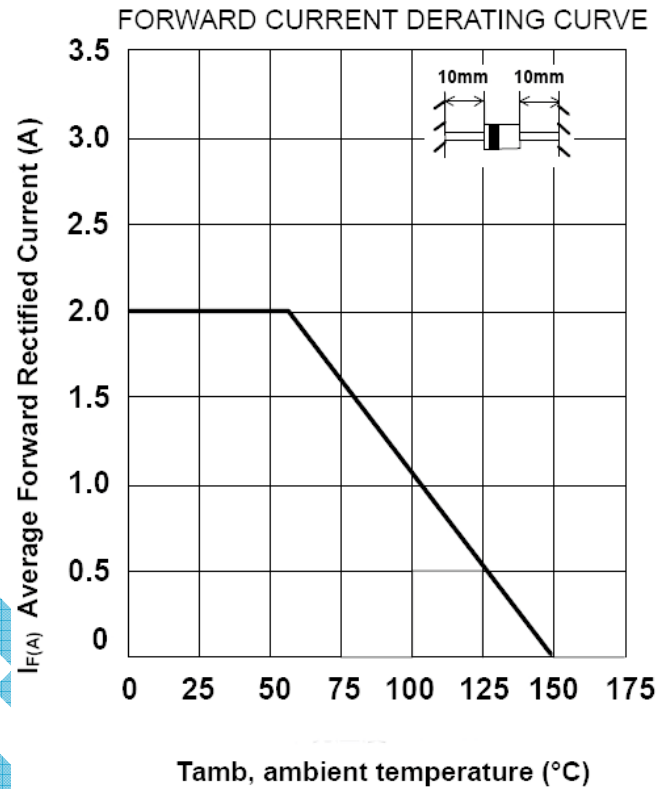
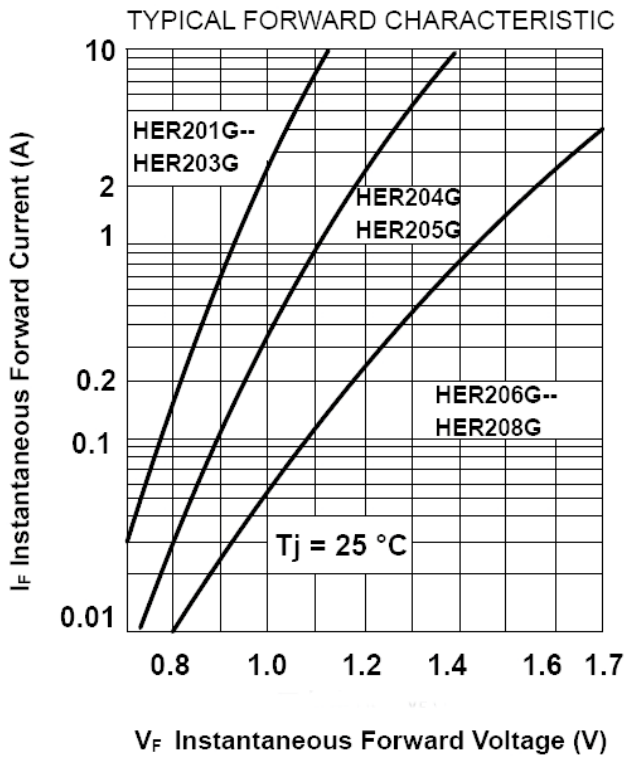

DO-15

SPECIFICATION

Tape in box (paper tape)

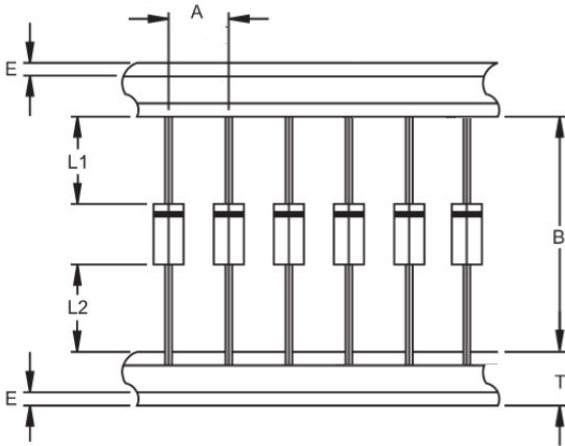

Taping Dimensions	A +/- 0,5mm	B +/- 1,5mm	T	E	L1-L2
DO-15	0,5mm	52,4mm	2,75~6,4	0,8max	±1,2

DO-15

High-efficiency Rectifier

This axial-lead component's packaging requirements use in automatic testing and assembly equipment. And this standard practices for lead-tape packaging of axial-lead components meets the requirements of EIA Standard RS-296-D "Lead-taping of Components on Axial Lead Configuration for Automatic Insertion".

Tape & Ammo Outline

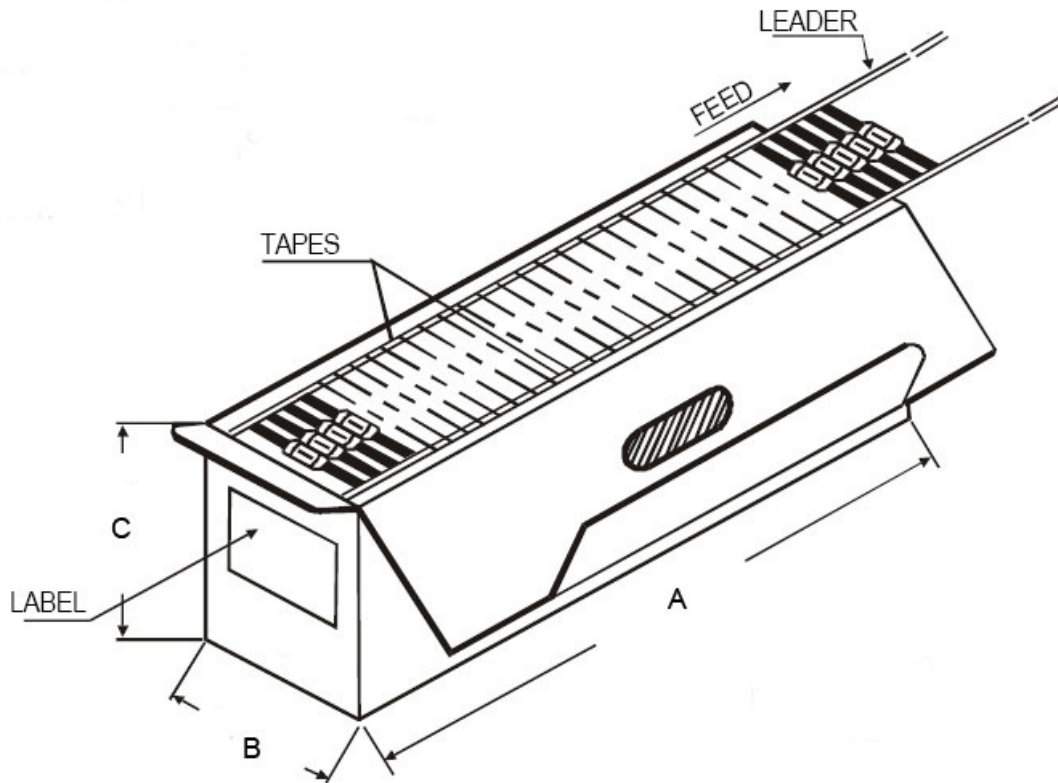

Packaging	Available Product Outlines	Dimension "A"	Dimension "B"	Dimension "C"	Quantity Box
52mm Horizontal Ammo Pack	DO-15	255mm	73mm	77mm	1,5K

Stock period

The performance of these products, including the solderability, is guaranteed for 12 month, provided that they remain packed as they were when delivered and stored at a temperature of 0-35°C and a relative humidity 35-75%RH

Lead Free Reflow Soldering Profile

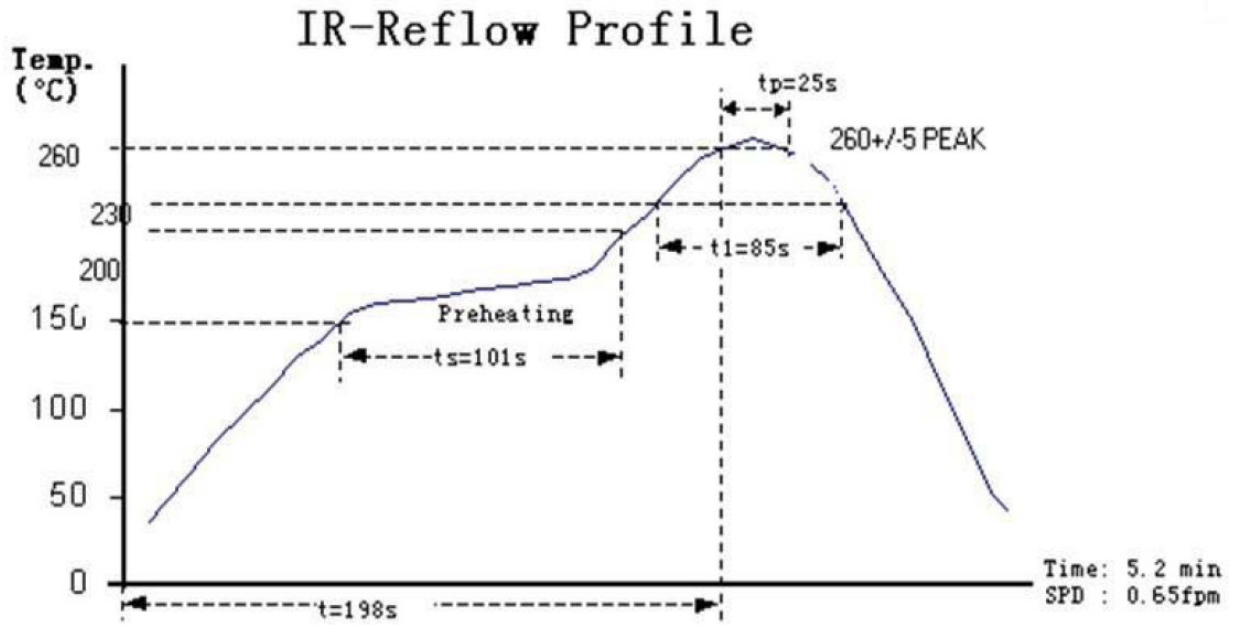

Freltec

DO-15

Published by FrelTec® GmbH
Mathildenstr. 10A; 82319 Starnberg; Germany
© 2020 FrelTec® GmbH. All Rights Reserved.

The following applies to all products named in this publication:

1. The information describes the type of component and shall not be considered as assured characteristics.
2. Terms of delivery and rights to change design reserved.
3. Some parts of this publication contain statements about the suitability of our products for certain areas of application. These statements are based on our knowledge of typical requirements that are often placed on our products in the areas of application concerned. Nevertheless, we explicitly point out that such statements cannot be regarded as binding statements about the suitability of our products for a particular customer application. As a rule, FrelTec® is either unfamiliar with individual customer applications or less familiar with them than the customers themselves. For these reasons, it is always ultimately incumbent on the customer to check and decide whether a FrelTec® product with the properties described in the product specification is suitable for use in a particular customer application.
4. We also point out that in individual cases, a malfunction of electronic components or failure before the end of their usual service life cannot be completely ruled out in the current state of the art, even if they are operated as specified. In customer applications requiring a very high level of operational safety and especially in customer applications in which the malfunction or failure of an electronic component could endanger human life or health (e.g. in accident prevention or life-saving systems), it must therefore be ensured by means of suitable design of the customer application or other action taken by the customer (e.g. installation of protective circuitry or redundancy) that no injury or damage is sustained by third parties in the event of malfunction or failure of an electronic component.
5. The warnings, cautions and product-specific notes must be observed.
6. In order to satisfy certain technical requirements, some of the products described in this publication may contain substances subject to restrictions in certain jurisdictions (e.g. because they are classed as "hazardous"). Useful information on this will be found in our Material Data Sheets. Should you have any more detailed questions, please contact our sales offices.
7. We constantly strive to improve our products. Consequently, the products described in this publication may change from time to time. The same is true for the corresponding product specifications. Please check therefore to what extent product descriptions and specifications contained in this publication are still applicable before or when you place an order. We also reserve the right to discontinue production and delivery of products. Consequently, we cannot guarantee that all products named in this publication will always be available.
8. Unless otherwise agreed in individual contracts, all orders are subject to the current version of the "General conditions for the supply of products and services of the electrical and electronics industry" published by the German Electrical and Electronics Industry Association (ZVEI), available at www.freltec.com.
9. As far as patents or other rights of third parties are concerned, liability is only assumed for components per se, not for applications, processes and circuits implemented within components or assemblies.
10. The trade name FrelTec® is a trademark registered or pending in Europe and in other countries.